

Version	2.0	Date	9/26/19
Prepared By	JC		

PRODUCT SPECIFICATION			
Category	Vapor Tight		
Item Number	9280		
Stock Code	LED-FXVTL52/48FR/850		
Mounting	Ceiling		
Housing Color	Gray + Frosted Lens		
PICTURE			

ELECTRICAL CHARACTERISTICS			
Rated Wattage (W)	52	Replacement Wattage (W)	4 x 32W T8
Tested Wattage (W)	50.81		
Input Voltage (V)	120-277V	Surge Protect Level	4KV
Voltage Frequency (Hz)	50/60	Dimmable	1-10V
Input Current (A)	0.4277	AUX (12V) Line	-
Power Factor	>0.9		
THD	<20%		

PHOTOMETRIC CHARACTERISTICS			
Lumen (lm)	7,092	CCT (K)	5000
Efficacy (lm/w)	136	Beam Angle (°)	110°
CRI	>80		

GENERAL CHARACTERISTICS	
Operating Temperature (°F)	-22°F ~ 122°
Storage Temperature (°F)	-40°F ~ 158°
IP Rating	IP65
IK Rating	-
Rated Life (Hrs)	50,000
Warranty (Yrs)	5

ACCESSORIES		
Item #	Stock Code	Description
K234301	FXVTL-MC605VD-MT	Motion Sensor Kit
K7334300	FXVTL-BAEM-MT	Emergency Driver with Mounting Plate

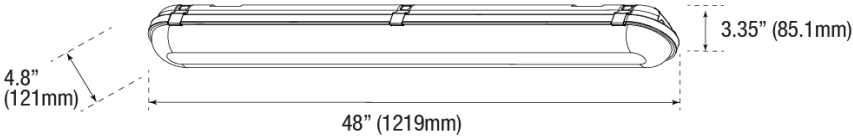
PRODUCT DIMENSIONS			
Width- in / (mm)	48"	1219	
Height- in / (mm)	3.35"	85.1	
Depth- in / (mm)	4.80"	121	
IK Rating	-		
Weight (lbs)	6.3		
Mounting Height (ft)	-		
Cable Length (ft)	-		

CERTIFICATIONS			
UL/ETL	ETL	CEC	
NSF/ETL Sanitation		JA8	
Energy Star		FCC	✓
DLC		RoHs	✓

DOCUMENTS			
LM79	✓	IES File	✓
LM80	✓	Dimmer List	

COMMENTS